

SECTION 2: GLASS FIXINGS

INDEX

| Product | Page |
|--|-------------|
| Uncovered Counter Sunk Bushes - Black or White | 2.1 |
| Covered Counter Sunk Bushes - 304SSS Cap | 2.2 |
| Anchor Spanner | 2.3 |
| Button Head Fixings | 2.4 |
| Button Heads, Spacers, Lagscrew, Threaded Rod | 2.5 |
| Nuts, Washer, Gaskets | 2.6 |
| Button Head Standoff Anchors | 2.7 |
| Covered Countersunk Standoff Anchors | 2.8 |
| Glass Standoff Anchor Order Request / Price Request Form | 2.9 |

Please Note: Special Size Standoffs to Order P.O.A



*** Surcharge applies for special orders of less than 20 units.**

*** For Frameless Glass Balustrade Fittings see Section "5" of this catalogue**

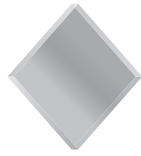
Lead time and pricing available from customer services between 8am - 5pm on 0800 545 800

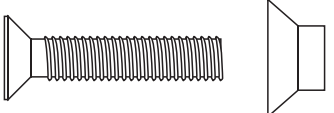
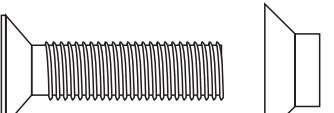

GLASS FIXINGS - UNCOVERED COUNTERSUNK BUSHES

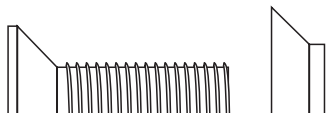
| Set Screws Uncovered Bushes | Code | Description | Price |
|--|-------|---|-------|
|  <p>M6 UCB6</p> | UCB6 | <p>Bush to Suit 8 & 10mm Glass UCB6 Bush only UCB6 Bush with CSK screw up to 50mm Specify Wood or Metal Fix screw ØA = 18mm ØB = 10mm Specify Black or White Colour Bush</p> | |
|  <p>M8 UCB8</p> | UCB8 | <p>Bush to Suit 8, 10 & 12mm Glass UCB8 Bush only UCB8 Bush with CSK screw up to 50mm Specify Wood or Metal Fix screw ØA = 20mm ØB = 12mm Specify Black or White Colour Bush</p> | |
|  <p>M10 UCB10</p> | UCB10 | <p>Bush to Suit 8, 10 & 12mm Glass UCB10 Bush only UCB10 Bush with M10 x 50 Stainless Steel Set Screw ØA = 24mm ØB = 16mm Specify Black or White Colour Bush</p> | |
|  <p>M12 UCB12</p> | UCB12 | <p>Bush to Suit 10, 12 & 15mm Glass UCB12 Bush only UCB12 Bush with M12 x 50 Stainless Steel Set Screw ØA = 28mm ØB = 18mm Specify Black or White Colour Bush</p> | |

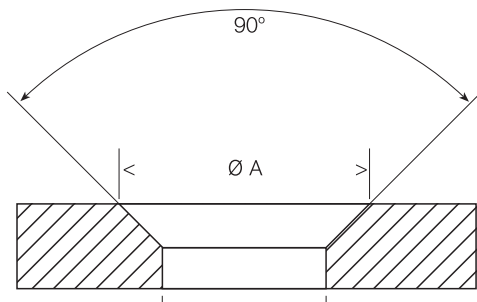

HOLE PREPARATION

Lead time and pricing available from customer services between 8am - 5pm on 0800 545 800

GLASS FIXINGS - COVERED COUNTERSUNK BUSHES

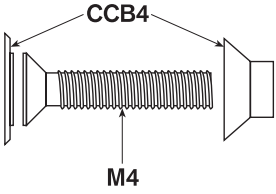
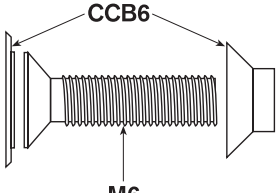
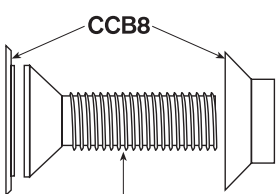
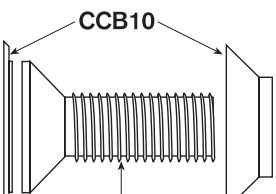
| Set Screws Covered Bushes | Code | Description | Price |
|--|-------|--|-------|
|  <p>CCB4 M4</p> | CCB4 | Stainless Steel Covered Bush to Suit 6mm Glass CCB4 Covered Bush only CCB4 Bush with M4 x 25mm Stainless Steel Screw Specify Wood or Metal Fix Screw $\text{ØA} = 16\text{mm}$ $\text{ØB} = 7\text{mm}$ | |
|  <p>CCB6 M6</p> | CCB6 | Stainless Steel Covered Bush to Suit 8 & 10mm Glass CCB6 Covered Bush only CCB6 Bush with M6 x 50mm Stainless Steel Screw Specify Wood or Metal Fix Screw $\text{ØA} = 22\text{mm}$ $\text{ØB} = 10\text{mm}$ | |
|  <p>CCB8 M8</p> | CCB8 | Stainless Steel Covered Bush to Suit 8, 10 & 12mm Glass CCB8 Covered Bush only CCB8 Bush with M8 x 50mm Stainless Steel Screw Specify Wood or Metal Fix Screw $\text{ØA} = 26\text{mm}$ $\text{ØB} = 14\text{mm}$ | |
|  <p>CCB10 M10</p> | CCB10 | Stainless Steel Covered Bush to Suit 10, 12 & 15mm Glass CCB10 Covered Bush only CCB10 Bush with M10 x 50mm Stainless Steel Socket Screw $\text{ØA} = 30\text{mm}$ $\text{ØB} = 18\text{mm}$ | |

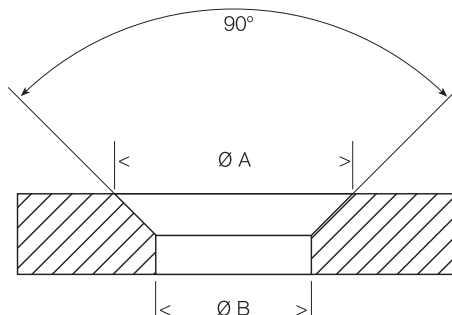

HOLE PREPARATION

Lead time and pricing available from customer services between 8am - 5pm on 0800 545 800

GLASS FIXINGS - ANCHOR SPANNERS

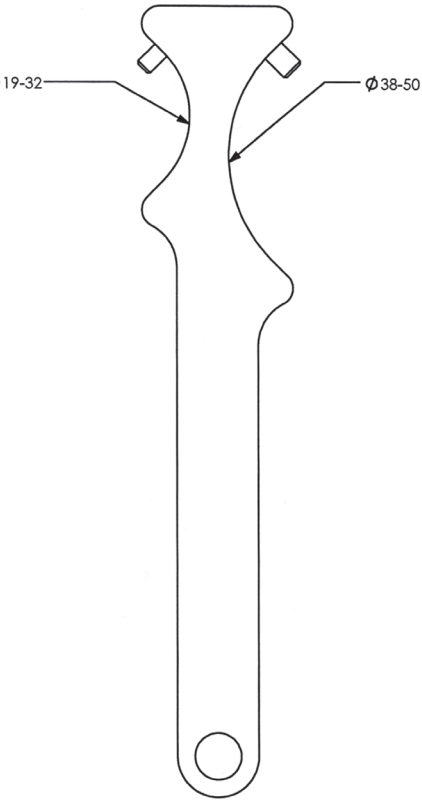
| Produce | Code | Description | Price |
|--|----------------|--|-------|
|  | <p>SP19-50</p> | <p>Anchor Spanner to Suit 19mm to 50mm diameter Anchors</p> | |

Lead time and pricing available from customer services between 8am - 5pm on 0800 545 800

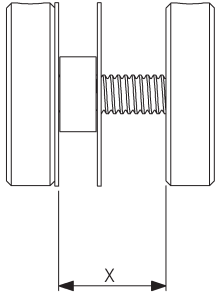
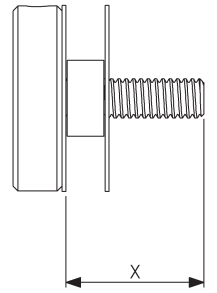
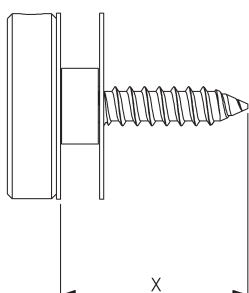

GLASS FIXINGS - BUTTON HEADS

| Button Head Fixings | Code | Description 304 Stainless Steel Buttons | Price |
|---|--------|--|---|
|  <p>"X" equals tightened thread length between button heads.</p> | DB19-X | Double Button Heads 19mm diameter | |
| | DB25-X | Double Button Heads 25mm diameter | |
| | DB32-X | Double Button Heads 32mm diameter | |
| | DB38-X | Double Button Heads 38mm diameter | |
| | DB50-X | Double Button Heads 50mm diameter | |
| | | | All double button heads are supplied with two nylon washers and sleeve. |
|  <p>"X" equals length of rod.</p> | BT19-X | Button Head 19mm diameter | |
| | BT25-X | Button Head 25mm diameter | |
| | BT32-X | Button Head 32mm diameter | |
| | BT38-X | Button Head 38mm diameter | |
| | BT50-X | Button Head 50mm diameter | |
| | | | All single button heads are supplied with two nylon washers and sleeve. |
|  <p>"X" equals length of Lag Screw. Minimum length 25mm Maximum length 55mm. Note: 50mm diameter minimum length 50mm</p> | BL19-X | Button Head 19mm diameter with Lag Screw | |
| | BL25-X | Button Head 25mm diameter with Lag Screw | |
| | BL32-X | Button Head 32mm diameter with Lag Screw | |
| | BL38-X | Button Head 38mm diameter with Lag Screw | |
| | BL50-X | Button Head 50mm diameter with Lag Screw | |
| | | | All single button heads are supplied with two nylon washers and sleeve. |
| | | Note: Lag Screw and Rod sizes 19mm Button - M6 } Minimum Lag Screw length 25mm 25mm Button - M6 } 32mm Button - M8 } Minimum Lag Screw length 30mm 38mm Button - M8 } 50mm Button - M10 - Minimum Lag Screw length 50mm | |

Lead time and pricing available from customer services between 8am - 5pm on 0800 545 800





GLASS FIXINGS - BUTTON HEADS & SPACERS

| Product | Code | Description | Price |
|-----------|---------------------------------|---|-------|
| | | 304SSS Button with LDPE Washer & Sleeve | |
| | BH19 | 19mm Dia Button Head M6 thread | |
| | BH25 | 25mm Dia Button Head M6 thread | |
| | BH32 | 32mm Dia Button Head M8 thread | |
| | BH38 | 38mm Dia Button Head M8 thread | |
| | BH50 | 50mm Dia Button Head M10 thread 50mm Button 316SSS | |
| | | 304SSS Spacer with LDPE Washer | |
| | SP19-5 | 19mm Dia x 5mm Spacer 7mm hole | |
| | SP25-5 | 25mm Dia x 5mm Spacer 7mm hole | |
| | SP32-5 | 32mm Dia x 5mm Spacer 8.5mm hole | |
| | SP38-5 | 38mm Dia x 5mm Spacer 8.5mm hole | |
| | SP50-6 | 50mm Dia x 6mm Spacer 10.5mm hole 50mm Spacer 316SSS | |
| | | 304SSS Spacer with LDPE Washer | |
| | SP19-10 | 19mm Dia x 10mm Spacer 7mm hole | |
| | SP25-10 | 25mm Dia x 10mm Spacer 7mm hole | |
| | SP32-10 | 32mm Dia x 10mm Spacer 8.5mm hole | |
| | SP38-10 | 38mm Dia 10mm Spacer 8.5mm hole | |
| | SP50-20 | 50mm Dia 20mm Spacer 10.5mm hole 50mm Spacer 316SSS | |
| | | Lag Screws | |
| | M6-50ZL | M6 x 50mm Zinc Plated | |
| | M8-50ZL | M8 x 50mm Zinc Plated | |
| | M10-75ZL | M10 x 75mm Zinc Plated | |
| | M10-100ZL | M10 x 100mm Zinc Plated | |
| | M10-120ZL | M10 x 120mm Zinc Plated | |
| | M8-80SL | M8 x 80mm Stainless Steel 304 | |
| M10-100SL | M10 x 100mm Stainless Steel 304 | | |
| | | Threaded Rods | |
| | M6-R25 | M6 x 25mm Stainless Steel 304 | |
| | M6-R32 | M6 x 32mm Stainless Steel 304 | |
| | M6-R60 | M6 x 60mm Stainless Steel 304 | |
| | M8-R25 | M8 x 25mm Stainless Steel 304 | |
| | M8-R60 | M8 x 60mm Stainless Steel 304 | |
| | M10-R25 | M10 x 25mm Stainless Steel 304 | |
| | M10-R60 | M10 x 60mm Stainless Steel 304 | |
| | M10-R100 | M10 x 100mm Stainless Steel 304 | |
| | M10-R115 | M10 x 115mm Stainless Steel 304 | |

Lead time and pricing available from customer services between 8am - 5pm on 0800 545 800

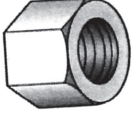
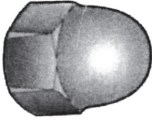

GLASS FIXINGS - NUTS, WASHER, GASKETS

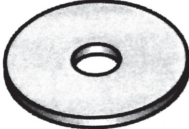
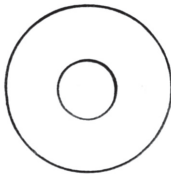
| Product | Code | Description | Price |
|---|----------|---|-------|
|  | | Hex Nuts | |
| | M6-HN | M6 Stainless Steel 304SS | |
| | M8-HN | M8 Stainless Steel 304SS | |
| | M10-HN | M10 Stainless Steel 316SS | |
|  | | Dome Nuts | |
| | M6-DN | M6 Stainless Steel 304SS | |
| | M8-DN | M8 Stainless Steel 304SS | |
| | M10-DN | M10 Stainless Steel 304SS | |
|  | | Spring Washers | |
| | M6-SW | M6 Stainless Steel 304SS | |
| | M8-SW | M8 Stainless Steel 304SS | |
| | M10-SW | M10 Stainless Steel 316SS | |
|  | | Flat Washers | |
| | M6-FW12 | M6 x 1mm x 12.5mm 304SS | |
| | M6-FW25 | M6 x 1.6mm x 25mm 304SS | |
| | M8-FW16 | M8 x 1.2mm x 16mm 304SS | |
| | M8-FW24 | M8 x 2mm x 24mm 304SS | |
| | M10-FW21 | M10 x 2mm x 21mm 304SS | |
| | M10-FW30 | M10 x 2.5mm x 30mm 304SS | |
| | M10-FW50 | M10 x 3mm x 50mm 316SS | |
|  | | L.D.P.E. Gasket Washers (Opaque) | |
| | LG-16 | M6 x .8mm x 16mm | |
| | LG-19 | M8 x .8mm x 19mm | |
| | LG-23 | M8 x .8mm x 23mm | |
| | LG-30 | M8 x .8mm x 31mm | |
| | LG-36 | M8 x .8mm x 36mm | |
| | LG-50 | M10 x .8mm x 50mm | |
| | | Specials | |

Lead time and pricing available from customer services between 8am - 5pm on 0800 545 800



GLASS FIXINGS - BUTTON HEAD STANDOFF ANCHORS

| Code | Description 304 Satin Stainless Steel Anchors | Price |
|----------------|--|-------|
| GSBH - 19 x 25 | Stainless Steel Button Head 19mm diameter x 25mm standoff | |
| GSBH - 19 x 50 | Stainless Steel Button Head 19mm diameter x 50mm standoff | |
| GSBH - 25 x 25 | Stainless Steel Button Head 25mm diameter x 25mm standoff | |
| GSBH - 25 x 50 | Stainless Steel Button Head 25mm diameter x 50mm standoff | |
| GSBH - 32 x 25 | Stainless Steel Button Head 32mm diameter x 25mm standoff | |
| GSBH - 32 x 50 | Stainless Steel Button Head 32mm diameter x 50mm standoff | |

- When ordering, specify 50mm threaded rod or woodfix lag screw for wall fixing.
- Anchor diameter 19mm and 25mm – use M6 threaded rod and lag screw.
- Anchor diameter 32mm – use M8 threaded rod and lag screw.

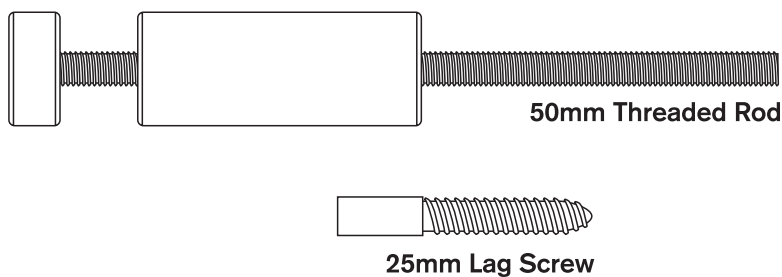

Please note

Custom size anchors available on request.

Simply fill in the order/enquiry form (page 2.9) and fax for quotations and orders.

For custom sizes allow 7 working days lead time.

Lead time and pricing available from customer services between 8am - 5pm on 0800 545 800

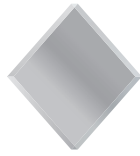

GLASS FIXINGS - COVERED COUNTERSUNK STANDOFF ANCHORS

| Code | Description 304 Satin Stainless Steel Anchors | Price |
|----------------|--|-------|
| GSCC - 19 x 25 | Stainless Steel Covered Countersunk 19mm diameter x 25mm standoff | |
| GSCC - 19 x 50 | Stainless Steel Covered Countersunk 19mm diameter x 50mm standoff | |
| GSCC - 25 x 25 | Stainless Steel Covered Countersunk 25mm diameter x 25mm standoff | |
| GSCC - 25 x 50 | Stainless Steel Covered Countersunk 25mm diameter x 50mm standoff | |
| GSCC - 32 x 25 | Stainless Steel Covered Countersunk 32mm diameter x 25mm standoff | |
| GSCC - 32 x 50 | Stainless Steel Covered Countersunk 32mm diameter x 50mm standoff | |

- When ordering, specify 50mm threaded rod or woodfix lag screw for wall fixing.
- Anchor diameter 19mm and 25mm – use M6 threaded rod, lag screw and CCB6 Bush.
- Anchor diameter 32mm – use M8 threaded rod, lag screw and CCB8 Bush.

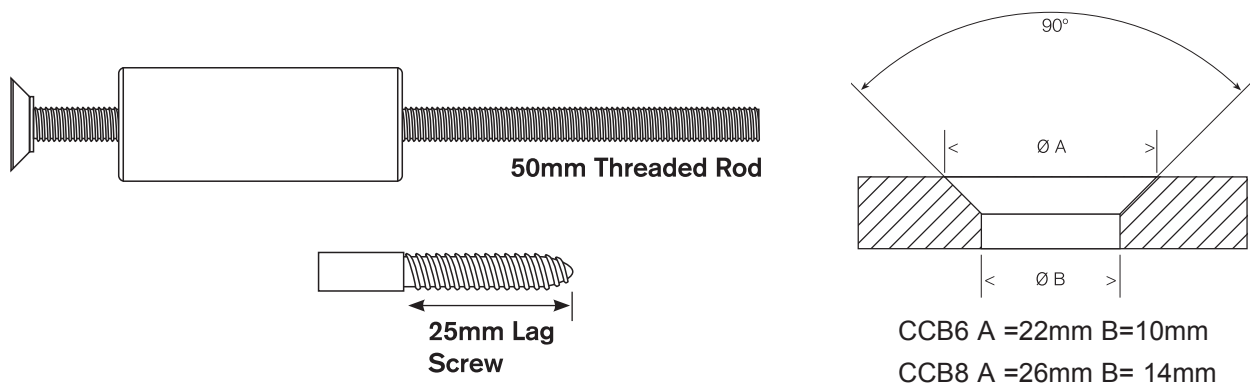

Please note

Custom size anchors available on request. P.O.A.
 Simply fill in the order/enquiry form (page 2.9) and fax for quotations and orders.
 For custom sizes allow 7 working days lead time.

Lead time and pricing available from customer services between 8am - 5pm on 0800 545 800

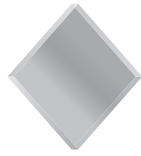

Fax Order/Quotation Form

GLASS STANDOFF ANCHORS

Order Request Price Request

Company Name: _____ Order Number: _____

Contact Name: _____ Date: _____

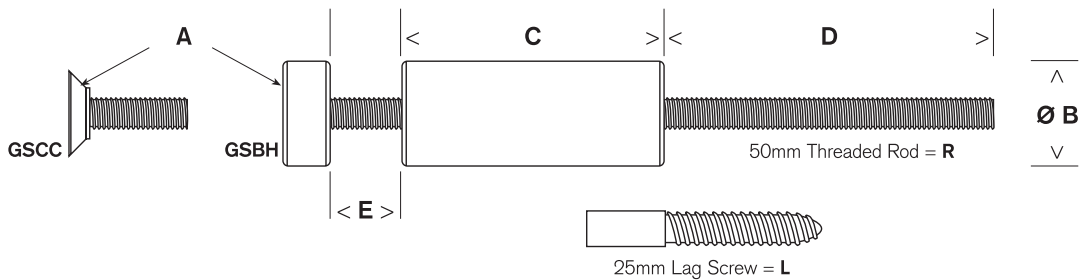

| | | | |
|--------------------------------|--|--------------|----------------------|
| A Head Type | Covered Countersunk Bush Button Head | GSCC GSBH | <input type="text"/> |
| B Glass Anchor Diameter | Ø19mm, Ø25mm, Ø32mm, Ø38mm - 304SSS, Ø50mm - 316SSS | | <input type="text"/> |
| C Standoff Length | 25mm, 50mm, Special length (specify) | | <input type="text"/> |
| D Fixing Type | Threaded Rod, 50mm long Wood Fix Lag Screw, 25mm long | R L | <input type="text"/> |
| E Glass Thickness | 6mm, 8mm, 10mm, 12mm, 15mm, 19mm, Other (mm) | | <input type="text"/> |
| F Quantity Required | | | <input type="text"/> |

| Anchor Diameter | Thread Size | Glass Hole Size For Button Head |
|-----------------|-------------|---------------------------------|
| Ø19mm and Ø25mm | M6 | 10mm |
| Ø32mm and Ø38mm | M8 | 12mm |
| Ø50mm | M10 | 16mm |

Note

Before drilling or countersinking glass check catalogue for correct dimensions.

CCB HOLE PREPARATION

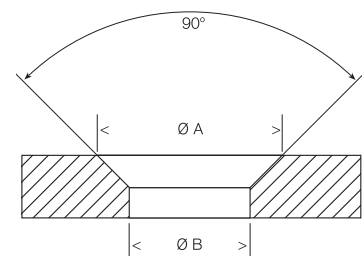

| Anchor Diameter | Counter Sunk Head Type | Glass Counter Sunk Dimensions |
|-----------------|------------------------|-------------------------------|
| Ø19mm x Ø25mm | CCB6 | A=22mm B=10mm |
| Ø32mm x Ø38mm | CCB8 | A=26mm B=14mm |
| Ø50mm | CCB10 | A=30mm B=18mm |

Lead time and pricing available from customer services between 8am - 5pm on 0800 545 800